

Low Voltage 1:15 Differential ECL/PECL Clock Divider and Fanout Buffer

The Motorola MC100ES6222 is a bipolar monolithic differential clock fanout buffer. Designed for most demanding clock distribution systems, the MC100ES6222 supports various applications that require the distribution of precisely aligned differential clock signals. Using SiGe technology and a fully differential architecture, the device offers very low skew outputs and superior digital signal characteristics. Target applications for this clock driver is high performance clock distribution in computing, networking and telecommunication systems.

Features

- 15 differential ECL/PECL outputs (4 output banks)
- 2 selectable differential ECL/PECL inputs
- Selectable ± 1 or ± 2 frequency divider
- 130 ps maximum device skew
- Supports DC to 3 GHz input frequency
- Single 3.3V, -3.3V, 2.5V or -2.5V supply
- Standard 52 lead LQFP package with exposed pad for enhanced thermal characteristics
- Supports industrial temperature range
- Pin and function compatible to the MC100EP222

Functional Description

The MC100ES6222 is designed for low skew clock distribution systems and supports clock frequencies up to 3 GHz. The CLK0 and CLK1 inputs can be driven by ECL or PECL compatible signals. Each of the four output banks of two, three, four and six differential clock output pairs can be independently configured to distribute the input frequency or ± 2 of the input frequency. The FSELA, FSELB, FSELC, FSELD and CLK_SEL are asynchronous control inputs. Any changes of the control inputs require a MR pulse for resynchronization of the ± 2 outputs. For the functionality of the MR control input, see Figure 5, "Functional Diagram," on page 7.

In order to meet the tight skew specification of the device, both outputs of a differential output pair should be terminated, even if only one output is used. In the case where not all ten outputs are used, the output pairs on the same package side as the parts being used on that side should be terminated.

The MC100ES6222 can be operated from a single 3.3V or 2.5V supply. As most other ECL compatible devices, the MC100ES6222 supports positive (PECL) and negative (ECL) supplies. The MC100ES6222 is pin and function compatible to the MC100EP222.

MC100ES6222

**LOW-VOLTAGE
1:15 DIFFERENTIAL
ECL/PECL CLOCK DIVIDER
AND FANOUT DRIVER**

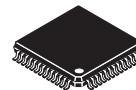

TB SUFFIX
52-LEAD LQFP PACKAGE
EXPOSED PAD
CASE 1336A

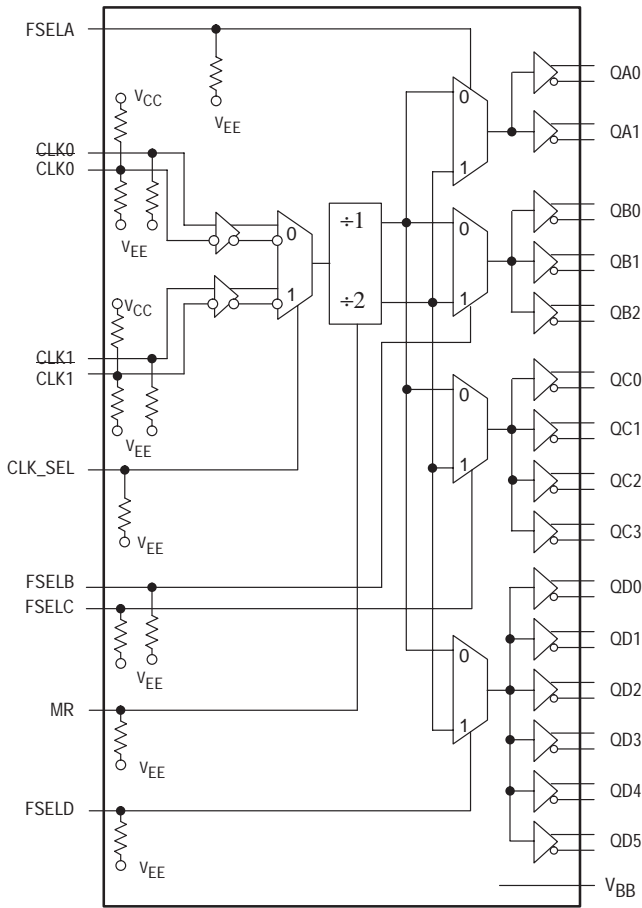

Figure 1. MC100ES6222 Logic Diagram

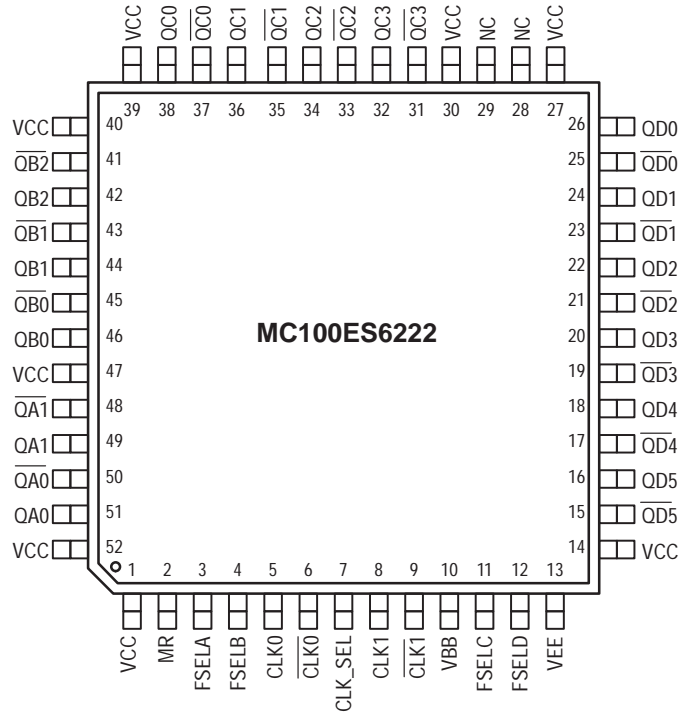

Figure 2. 52-Lead Package Pinout (Top View)

Table 1. Function Table

Control Pin	0	1
FSELA (asynchronous)	÷1	÷2
FSELB (asynchronous)	÷1	÷2
FSEL (asynchronous)	÷1	÷2
FSELD (asynchronous)	÷1	÷2
CLK_SEL (asynchronous)	CLK0	CLK1
MR (asynchronous)	Active	Reset. Q _X = L and Q _X = H.

Table 2. Pin Configuration

Pin	I/O	Type	Description
CLK0, CLK0	Input	ECL/PECL	Differential reference clock signal input
CLK1, CLK1	Input	ECL/PECL	Alternative differential reference clock signal input
FSELA, FSELB, FSELC, FSELD	Input	ECL/PECL	Selection output frequency divider for bank A, B, C and D
MR	Input	ECL/PECL	Reset
CLK_SEL	Input	ECL/PECL	Clock reference select input
QA[0:1], QA[0:1]	Output	ECL/PECL	Bank A differential outputs
QB[0:2], QB[0:2]	Output	ECL/PECL	Bank B differential outputs
QC[0:3], QC[0:3]	Output	ECL/PECL	Bank C differential outputs
QD[0:5], QD[0:5]	Output	ECL/PECL	Bank D differential outputs
VBB	Output	DC	Reference voltage output for single ended ECL or PECL operation
VEE ^a		Power supply	Negative power supply
VCC		Power supply	Positive power supply. All V _{CC} pins must be connected to the positive power supply for correct DC and AC operation.

a. In ECL mode (negative power supply mode), V_{EE} is either -3.3V or -2.5V and V_{CC} is connected to GND (0V). In PECL mode (positive power supply mode), V_{EE} is connected to GND (0V) and V_{CC} is either +3.3V or +2.5V. In both modes, the input and output levels are referenced to the most positive supply (V_{CC}).

Table 3. Absolute Maximum Ratings^a

Symbol	Characteristics	Min	Max	Unit	Condition
V _{CC}	Supply Voltage	-0.3	3.6	V	
V _{IN}	DC Input Voltage	-0.3	V _{CC} + 0.3	V	
V _{OUT}	DC Output Voltage	-0.3	V _{CC} + 0.3	V	
I _{IN}	DC Input Current		±20	mA	
I _{OUT}	DC Output Current		±50	mA	
T _S	Storage temperature	-65	125	°C	
T _{FUNC}	Functional temperature range	T _A = -40	T _J = +110	°C	

a. Absolute maximum continuous ratings are those maximum values beyond which damage to the device may occur. Exposure to these conditions or conditions beyond those indicated may adversely affect device reliability. Functional operation at absolute-maximum-rated conditions is not implied.

Table 4. General Specifications

Symbol	Characteristics	Min	Typ	Max	Unit	Condition
V _{TT}	Output termination voltage		V _{CC} - 2 ^a		V	
MM	ESD Protection (Machine model)	175			V	
HBM	ESD Protection (Human body model)	2000			V	
CDM	ESD Protection (Charged device model)	TBD			V	
LU	Latch-up immunity	200			mA	
C _{IN}	Input Capacitance		4.0		pF	Inputs
θ _{JA} , θ _{JC} θ _{JB}	Thermal resistance (junction-to-ambient, junction-to-board, junction-to-case)	See Table 9, "Thermal Resistance" on page 9			°C/W	
T _J	Operating junction temperature ^b (continuous operation) MTBF = 9.1 years	0		110	°C	

a. Output termination voltage V_{TT} = 0V for V_{CC} = 2.5V operation is supported but the power consumption of the device will increase.
 b. Operating junction temperature impacts device life time. Maximum continuous operating junction temperature should be selected according to the application life time requirements (See application note AN1545 for more information). The device AC and DC parameters are specified up to 110°C junction temperature allowing the MC100ES6222 to be used in applications requiring industrial temperature range. It is recommended that users of the MC100ES6222 employ thermal modeling analysis to assist in applying the junction temperature specifications to their particular application.

Freescale Semiconductor, Inc.

Table 5. PECL DC Characteristics ($V_{CC} = 2.5V \pm 5\%$ or $V_{CC} = 3.3V \pm 5\%$, $V_{EE} = GND$, $T_J = 0^{\circ}C$ to $+110^{\circ}C$)

Symbol	Characteristics	Min	Typ	Max	Unit	Condition
Clock input pair CLK0, CLK0, CLK1, CLK1 (PECL differential signals)						
V_{PP}	Differential Input Voltage ^a	0.1		1.3	V	Differential operation
V_{CMR}	Differential Cross Point Voltage ^b	1.0		$V_{CC} - 0.3$	V	Differential operation
I_{IN}	Input Current ^a			± 150	μA	$V_{IN} = V_{IL}$ or $V_{IN} = V_{IH}$
Clock inputs MR, CLK_SEL, FSELA, FSELB, FSELC, FSELD (PECL single ended signals)						
V_{IH}	Input Voltage High	$V_{CC} - 1.165$		$V_{CC} - 0.880$	V	
V_{IL}	Input Voltage Low	$V_{CC} - 1.810$		$V_{CC} - 1.475$	V	
I_{IN}	Input Current ^c			± 150	μA	$V_{IN} = V_{IL}$ or $V_{IN} = V_{IH}$
PECL clock outputs (QA[0:1], QA[0:1], QB[0:2], QB[0:2], QC[0:3], QC[0:3], QD[0:5], QD[0:5])						
V_{OH}	Output High Voltage	$V_{CC} - 1.1$	$V_{CC} - 1.005$	$V_{CC} - 0.7$	V	$I_{OH} = -30 mA^d$
V_{OL}	Output Low Voltage	$V_{CC} - 1.9$	$V_{CC} - 1.705$	$V_{CC} - 1.4$	V	$I_{OL} = -5 mA^d$
Supply current and V_{BB}						
I_{EE}^e	Maximum Quiescent Supply Current without output termination current		96	170	mA	V_{EE} pins
V_{BB}	Output reference voltage	$V_{CC} - 1.38$		$V_{CC} - 1.22$	V	$I_{BB} = 0.4 mA$

- a. V_{PP} (DC) is the minimum differential input voltage swing required to maintain device functionality.
- b. V_{CMR} (DC) is the crosspoint of the differential input signal. Functional operation is obtained when the crosspoint is within the V_{CMR} (DC) range and the input swing lies within the V_{PP} (DC) specification.
- c. Input have internal pullup/pulldown resistors which affect the input current.
- d. Equivalent to a termination of 50Ω to V_{TT} .
- e. I_{CC} calculation: $I_{CC} = (\text{number of differential output used}) \times (I_{OH} + I_{OL}) + I_{EE}$
 $I_{CC} = (\text{number of differential output used}) \times (V_{OH} - V_{TT}) / R_{load} + (V_{OL} - V_{TT}) / R_{load} + I_{EE}$.

Table 6. ECL DC Characteristics ($V_{EE} = -2.5V \pm 5\%$ or $V_{EE} = -3.3V \pm 5\%$, $V_{CC} = GND$, $T_J = T_J = 0^\circ C$ to $+110^\circ C$)

Symbol	Characteristics	Min	Typ	Max	Unit	Condition
Clock input pair CLK0, CLK0, CLK1, CLK1 (ECL differential signals)						
V _{PP}	Differential Input Voltage ^a	0.1		1.3	V	Differential operation
V _{CMR}	Differential Cross Point Voltage ^b	V _{EE} + 1.0		-0.3	V	Differential operation
I _{IN}	Input Current ^a			±150	µA	V _{IN} = V _{IL} or V _{IN} = V _{IH}
Clock inputs MR, CLK_SEL, FSELA, FSELB, FSELC, FSELD (PECL single ended signals)						
V _{IH}	Input Voltage High	-1.165		-0.880	V	
V _{IL}	Input Voltage Low	-1.810		-1.475	V	
I _{IN}	Input Current ^c			±150	µA	V _{IN} = V _{IL} or V _{IN} = V _{IH}
ECL clock outputs (QA[0:1], QA[0:1], QB[0:2], QB[0:2], QC[0:3], QC[0:3], QD[0:5], QD[0:5])						
V _{OH}	Output High Voltage	-1.1	-1.005	-0.7	V	I _{OH} = -30 mA ^d
V _{OL}	Output Low Voltage	-1.9	-1.705	1.4	V	I _{OL} = -5 mA ^d
Supply current and V _{BB}						
I _{EE} ^e	Maximum Quiescent Supply Current without output termination current		96	170	mA	V _{EE} pins
V _{BB}	Output reference voltage	-1.38		-1.22	V	I _{BB} = 0.4 mA

- a. V_{PP} (DC) is the minimum differential input voltage swing required to maintain device functionality.
- b. V_{CMR} (DC) is the crosspoint of the differential input signal. Functional operation is obtained when the crosspoint is within the V_{CMR} (DC) range and the input swing lies within the V_{PP} (DC) specification.
- c. Input have internal pullup/pulldown resistors which affect the input current.
- d. Equivalent to a termination of 50Ω to V_{TT}.
- e. I_{CC} calculation: I_{CC} = (number of differential output used) x (I_{OH} + I_{OL}) + I_{EE}
 $I_{CC} = (\text{number of differential output used}) \times (V_{OH} - V_{TT}) \div R_{load} + (V_{OL} - V_{TT}) \div R_{load} + I_{EE}$.

Freescale Semiconductor, Inc.

Table 7. AC Characteristics (ECL: $V_{EE} = -3.3V \pm 5\%$ or $V_{EE} = -2.5V \pm 5\%$, $V_{CC} = GND$) or (PECL: $V_{CC} = 3.3V \pm 5\%$ or $V_{CC} = 2.5V \pm 5\%$, $V_{EE} = GND$, $T_J = 0^\circ C$ to $+110^\circ C$)^a

Symbol	Characteristics	Min	Typ	Max	Unit	Condition	
Clock input pair CLK0, CLK0, CLK1, CLK1 (PECL or ECL differential signals)							
V_{PP}	Differential input voltage ^b (peak-to-peak)	0.2		1.3	V		
V_{CMR}	Differential input crosspoint voltage ^c	PECL ECL 1.0 $V_{EE}+1.0$		$V_{CC} - 0.3$ -0.3V	V V		
f_{CLK}	Input Frequency	0		2000	MHz	Differential	
ECL/PECL clock outputs (QA[0:1], QA[0:1], QB[0:2], QB[0:2], QC[0:3], QC[0:3], QD[0:5], QD[0:5])							
t_{PD}	Propagation Delay	CLK0 or CLK1 to Qx MR to Qx	670	820	970	ps ps	Differential
$V_{O(P-P)}$	Differential output voltage (peak-to-peak)	$f_O < 1.0$ GHz $f_O < 2.0$ GHz	TBD TBD			mV mV	
$t_{sk(O)}$	Output-to-output skew	within QA[0:1] within QB[0:2] within QC[0:3] within QD[0:5] any output			35 35 50 60 130	ps ps ps ps ps	Differential
$t_{sk(PP)}$	Output-to-output skew (part-to-part)				300	ps	Differential
$t_{JIT(CC)}$	Output cycle-to-cycle jitter				TBD	ps	
$t_{SK(P)}$	Output pulse skew ^d			5	15	ps	
DC_O	Output Duty Cycle	$f_{REF} < 0.1$ GHz $f_{REF} < 1.0$ GHz $f_{REF} < 2.0$ GHz	49.85 48.50 47.00	50 50 50	50.15 51.50 53.00	% % %	$DC_{REF} = 50\%$ $DC_{REF} = 50\%$ $DC_{REF} = 50\%$
t_r, t_f	Output Rise/Fall Time		50		300	ps	20% to 80%

- a. AC characteristics apply for parallel output termination of 50Ω to V_{TT} .
- b. V_{PP} (AC) is the minimum differential ECL/PECL input voltage swing required to maintain AC characteristics including t_{pd} and device-to-device skew.
- c. V_{CMR} (AC) is the crosspoint of the differential ECL/PECL input signal. Normal AC operation is obtained when the crosspoint is within the V_{CMR} (AC) range and the input swing lies within the V_{PP} (AC) specification. Violation of V_{CMR} (AC) or V_{PP} (AC) impacts the device propagation delay, device and part-to-part skew.
- d. Output pulse skew is the absolute difference of the propagation delay times: $|t_{pLH} - t_{pHL}|$.

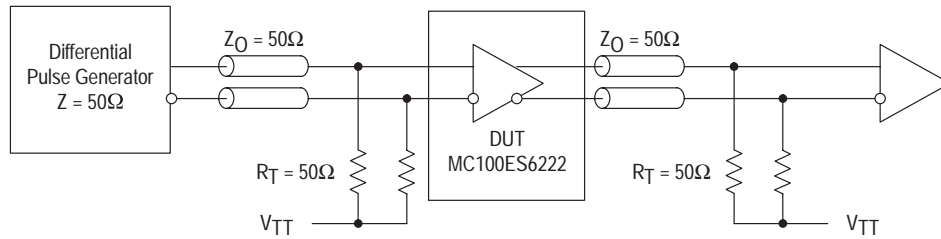

Figure 3. MC100ES6222 AC test reference

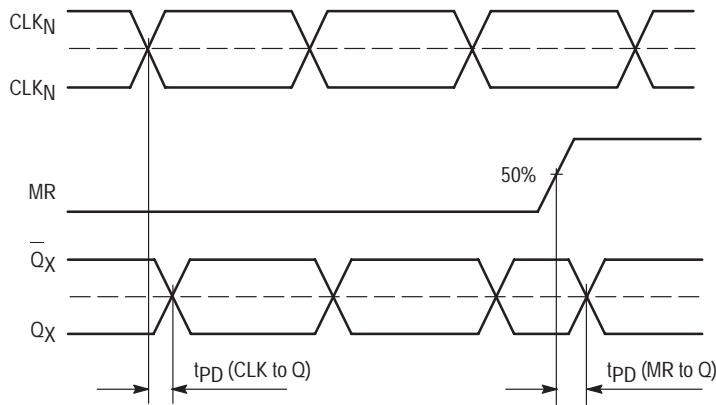

Figure 4. MC100ES6222 t_{pD} measurement waveform

APPLICATIONS INFORMATION

Asynchronous Reset Functional Diagram

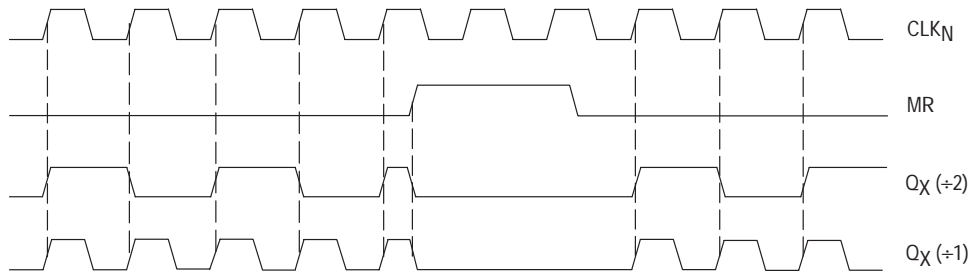

Figure 5. Functional diagram

APPLICATIONS INFORMATION

Understanding the junction temperature range of the MC100ES6222

To make the optimum use of high clock frequency and low skew capabilities of the MC100ES6222, the MC100ES6222 is specified, characterized and tested for the junction temperature range of $T_J=0^{\circ}\text{C}$ to $+110^{\circ}\text{C}$. Because the exact thermal performance depends on the PCB type, design, thermal management and natural or forced air convection, the junction temperature provides an exact way to correlate the application specific conditions to the published performance data of this datasheet. The correlation of the junction temperature range to the application ambient temperature range and vice versa can be done by calculation:

$$T_J = T_A + R_{thja} \cdot P_{tot}$$

Assuming a thermal resistance (junction to ambient) of 17°C/W (2s2p board, 200 ft/min airflow, see Table 9 on page 9) and a typical power consumption of 1026 mW (all outputs terminated 50 ohms to V_{TT} , $V_{CC}=3.3\text{V}$, frequency independent), the junction temperature of the MC100ES6222 is approximately $T_A + 17^{\circ}\text{C}$, and the minimum ambient temperature in this example case calculates to -17°C (the maximum ambient temperature is 93°C . See Table 8). Exceeding the minimum junction temperature specification of the MC100ES6222 does not have a significant impact on the device functionality. However, the continuous use of the MC100ES6222 at high ambient temperatures requires thermal management to not exceed the specified maximum junction temperature. Please see the application note AN1545 for a power consumption calculation guideline.

Table 8. Ambient temperature ranges ($P_{tot} = 1026\text{mW}$)

R _{thja} (2s2p board)		T _{A, min} ^a	T _{A, max}
Natural convection	20 °C/W	-21 °C	89 °C
100 ft/min	18 °C/W	-18 °C	92 °C
200 ft/min	17 °C/W	-17 °C	93 °C
400 ft/min	16 °C/W	-16 °C	94 °C
800 ft/min	15 °C/W	-15 °C	95 °C

a. The MC100ES6222 device function is guaranteed from $T_A=-40^{\circ}\text{C}$ to $T_J=110^{\circ}\text{C}$

Maintaining Lowest Device Skew

The MC100ES6222 guarantees low output-to-output bank skew of 130 ps and a part-to-part skew of max. 300 ps. To ensure low skew clock signals in the application, both outputs of any differential output pair need to be terminated identically, even if only one output is used. When fewer than all nine output pairs are used, identical termination of all output pairs within the output bank is recommended. This will reduce the device power consumption while maintaining minimum output skew.

Power Supply Bypassing

The MC100ES6222 is a mixed analog/digital product. The differential architecture of the MC100ES6222 supports low noise signal operation at high frequencies. In order to maintain its superior signal quality, all V_{CC} pins should be bypassed by high-frequency ceramic capacitors connected to GND. If the spectral frequencies of the internally generated switching noise on the supply pins cross the series resonant point of an individual bypass capacitor, its overall impedance begins to look inductive and thus increases with increasing frequency. The parallel capacitor combination shown ensures that a low impedance path to ground exists for frequencies well above the noise bandwidth.

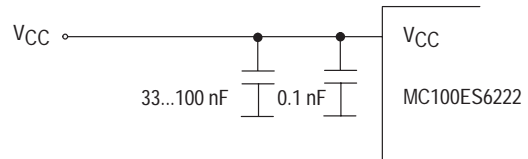

Figure 6. V_{CC} Power Supply Bypass

APPLICATIONS INFORMATION

Using the thermally enhanced package of the MC100ES6222

The MC100ES6222 uses a thermally enhanced exposed pad (EP) 52 lead LQFP package. The package is molded so that the leadframe is exposed at the surface of the package bottom side. The exposed metal pad will provide the low thermal impedance that supports the power consumption of the MC100ES6222 high-speed bipolar integrated circuit and eases the power management task for the system design. A thermal land pattern on the printed circuit board and thermal vias are recommended in order to take advantage of the enhanced thermal capabilities of the MC100ES6222. Direct soldering of the exposed pad to the thermal land will provide an efficient thermal path. In multilayer board designs, thermal vias thermally connect the exposed pad to internal copper planes. Number of vias, spacing, via diameters and land pattern design depend on the application and the amount of heat to be removed from the package. A nine thermal via array, arranged in a 3 x 3 array and using a 1.2 mm pitch in the center of the thermal land is a requirement for MC100ES6222 applications on multi-layer boards. The recommended thermal land design comprises a 3 x 3 thermal via array as shown in Figure 7. "Recommended thermal land pattern", providing an efficient heat removal path.

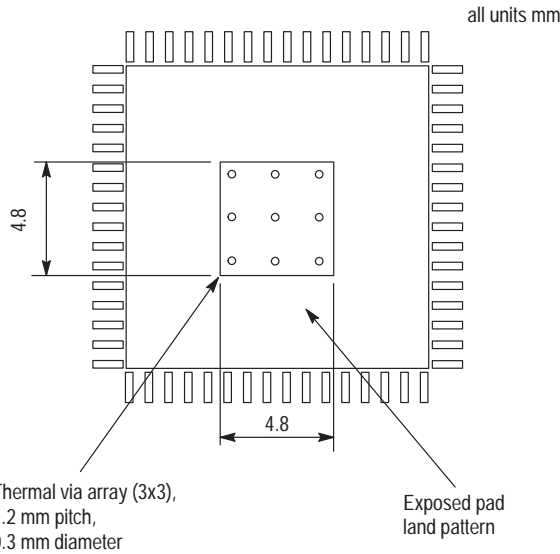

Figure 7. Recommended thermal land pattern

The via diameter is should be approx. 0.3 mm with 1 oz. copper via barrel plating. Solder wicking inside the via resulting in voids during the solder process must be avoided. If the copper plating does not plug the vias, stencil print solder paste onto the printed circuit pad. This will supply enough solder paste to fill those vias and not starve the solder joints. The attachment process for exposed pad package is equivalent to standard surface mount packages. Figure 8. "Recommended solder mask openings" shows a recommend solder mask opening with respect to the

recommended 3 x 3 thermal via array. Because a large solder mask opening may result in a poor release, the opening should be subdivided as shown in Figure 8. For the nominal package standoff 0.1 mm, a stencil thickness of 5 to 8 mils should be considered.

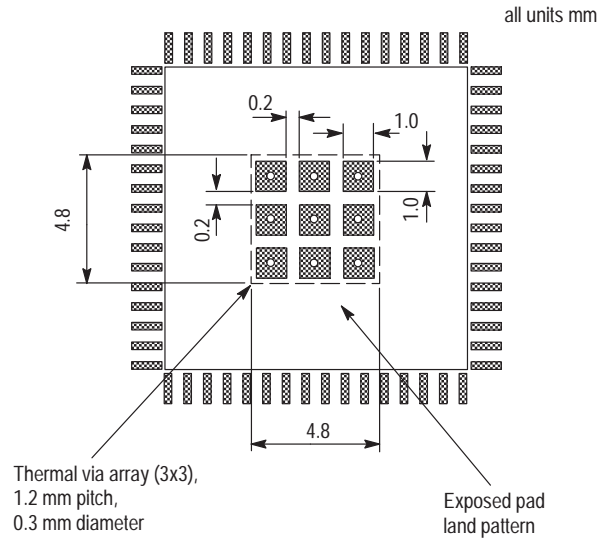

Figure 8. Recommended solder mask openings

For thermal system analysis and junction temperature calculation the thermal resistance parameters of the package is provided:

Table 9. Thermal Resistance^a

Convection-LFPM	R _{THJA} ^b °C/W	R _{THJA} ^c °C/W	R _{THJC °C/W}	R _{THJB} ^d °C/W
Natural	20	48	4 ^e 29 ^f	16
100	18	47		
200	17	46		
400	16	43		
800	15	41		

- a. Applicable for a 3 x 3 thermal via array
- b. Junction to ambient, four conductor layer test board (2S2P), per JES51-7 and JESD 51-5
- c. Junction to ambient, single layer test board, per JESD51-3
- d. Junction to board, four conductor layer test board (2S2P) per JESD 51-8
- e. Junction to exposed pad
- f. Junction to top of package

It is recommended that users employ thermal modeling analysis to assist in applying the general recommendations to their particular application. The exposed pad of the MC100ES6222 package does not have an electrical low impedance path to the substrate of the integrated circuit and its terminals. The thermal land should be connected to GND through connection of internal board layers.

OUTLINE DIMENSIONS

TB SUFFIX
 PLASTIC LQFP PACKAGE EXPOSED PAD
 CASE 1336A-01
 ISSUE 0

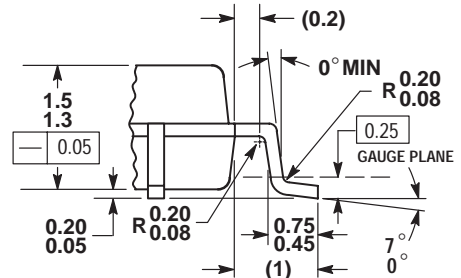
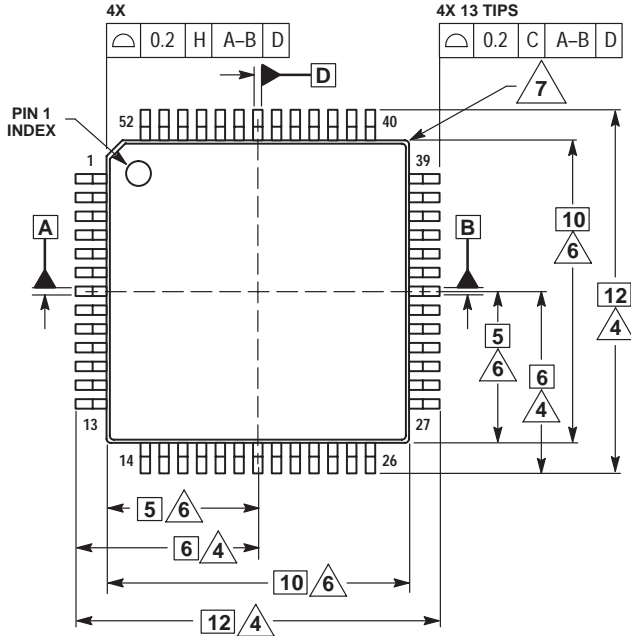

VIEW AA

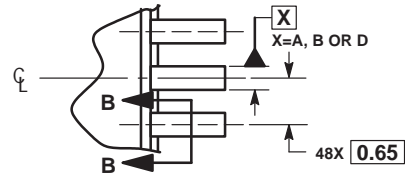

VIEW Y

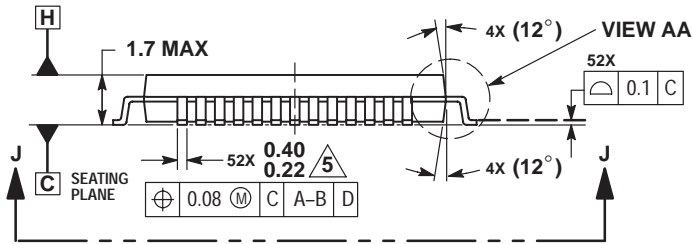

VIEW AA

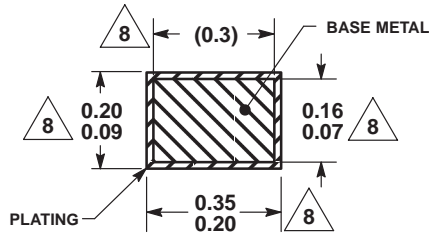

SECTION B-B

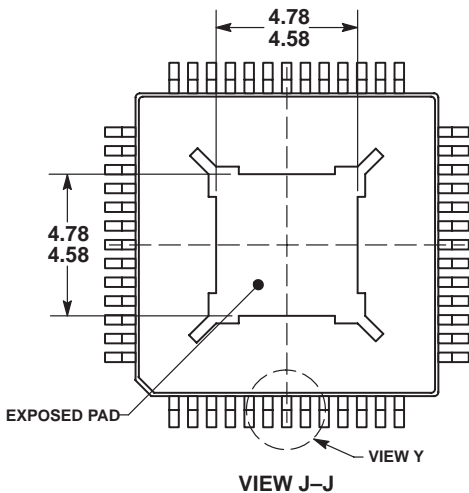

VIEW J-J

NOTES:

1. DIMENSIONS ARE IN MILLIMETERS.
2. INTERPRET DIMENSIONS AND TOLERANCES PER ASME Y14.5M-1994.
3. DATUMS A, B AND D TO BE DETERMINED AT DATUM PLANE H.
4. DIMENSION TO BE DETERMINED AT SEATING PLANE C.
5. THIS DIMENSION DOES NOT INCLUDE DAMBAR PROTRUSION. ALLOWABLE DAMBAR PROTRUSION SHALL NOT CAUSE THE LEAD WIDTH TO EXCEED 0.46 mm. DAMBAR CANNOT BE LOCATED ON THE LOWER RADIUS OR THE FOOT. MINIMUM SPACE BETWEEN PROTRUSION AND ADJACENT LEAD SHALL NOT BE LESS THAN 0.07 mm.
6. THIS DIMENSION DOES NOT INCLUDE MOLD PROTRUSION. ALLOWABLE PROTRUSION IS 0.25 mm PER SIDE. THIS DIMENSION IS MAXIMUM PLASTIC BODY SIZE DIMENSION INCLUDING MOLD MISMATCH.
7. EXACT SHAPE OF EACH CORNER IS OPTIONAL.
8. THESE DIMENSIONS APPLY TO THE FLAT SECTION OF THE LEAD BETWEEN 0.10 mm AND 0.25 mm FROM THE LEAD TIP.

NOTES

Freescale Semiconductor, Inc.

Motorola reserves the right to make changes without further notice to any products herein. Motorola makes no warranty, representation or guarantee regarding the suitability of its products for any particular purpose, nor does Motorola assume any liability arising out of the application or use of any product or circuit, and specifically disclaims any and all liability, including without limitation consequential or incidental damages. "Typical" parameters which may be provided in Motorola data sheets and/or specifications can and do vary in different applications and actual performance may vary over time. All operating parameters, including "Typicals" must be validated for each customer application by customer's technical experts. Motorola does not convey any license under its patent rights nor the rights of others. Motorola products are not designed, intended, or authorized for use as components in systems intended for surgical implant into the body, or other applications intended to support or sustain life, or for any other application in which the failure of the Motorola product could create a situation where personal injury or death may occur. Should Buyer purchase or use Motorola products for any such unintended or unauthorized application, Buyer shall indemnify and hold Motorola and its officers, employees, subsidiaries, affiliates, and distributors harmless against all claims, costs, damages, and expenses, and reasonable attorney fees arising out of, directly or indirectly, any claim of personal injury or death associated with such unintended or unauthorized use, even if such claim alleges that Motorola was negligent regarding the design or manufacture of the part. Motorola, Inc. Motorola, Inc. is an Equal Opportunity/Affirmative Action Employer. MOTOROLA and the  logo are registered in the US Patent & Trademark Office. All other product or service names are the property of their respective owners.

© Motorola, Inc. 2001.

How to reach us:

USA/EUROPE/Locations Not Listed: Motorola Literature Distribution; P.O. Box 5405, Denver, Colorado 80217. 1-303-675-2140 or 1-800-441-2447

JAPAN: Motorola Japan Ltd.; SPS, Technical Information Center, 3-20-1, Minami-Azabu. Minato-ku, Tokyo 106-8573 Japan. 81-3-3440-3569

ASIA/PACIFIC: Motorola Semiconductors H.K. Ltd.; Silicon Harbour Centre, 2 Dai King Street, Tai Po Industrial Estate, Tai Po, N.T., Hong Kong. 852-26668334

Technical Information Center: 1-800-521-6274

HOME PAGE: <http://www.motorola.com/semiconductors/>



MOTOROLA

**For More Information On This Product,
Go to: www.freescale.com**

MC100ES6222/D